

Places of Worship

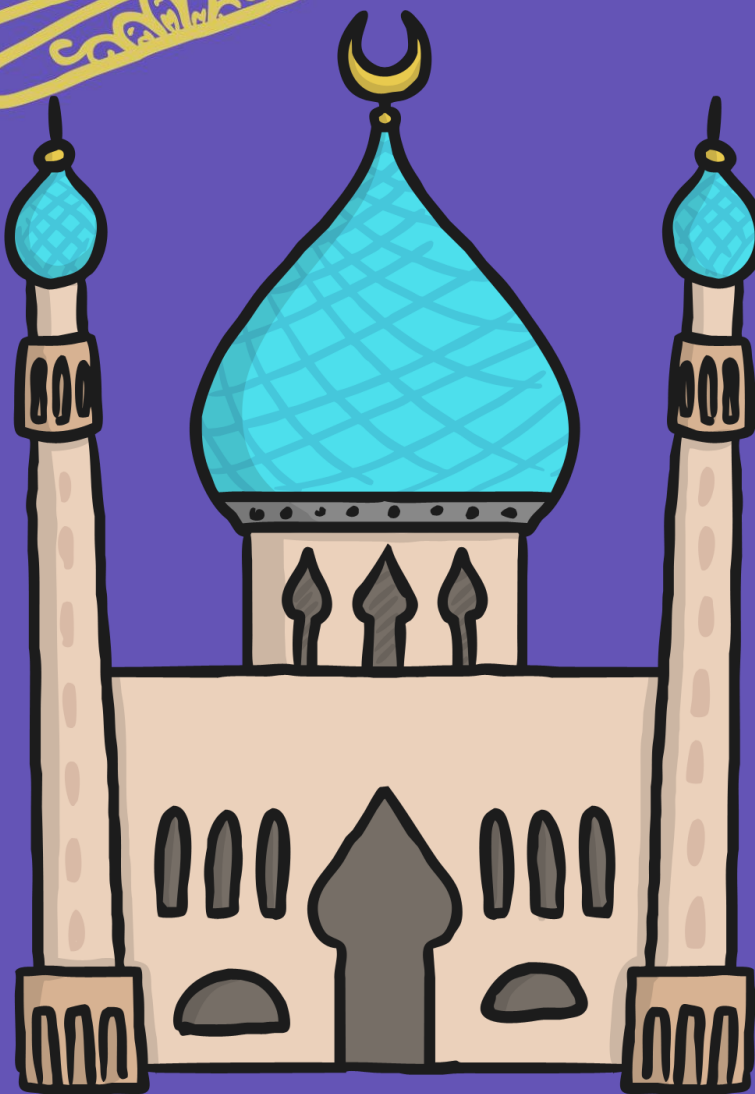

A task setting PowerPoint about the Muslim mosque for Key Stage 1.

What is it like inside a Muslim mosque?

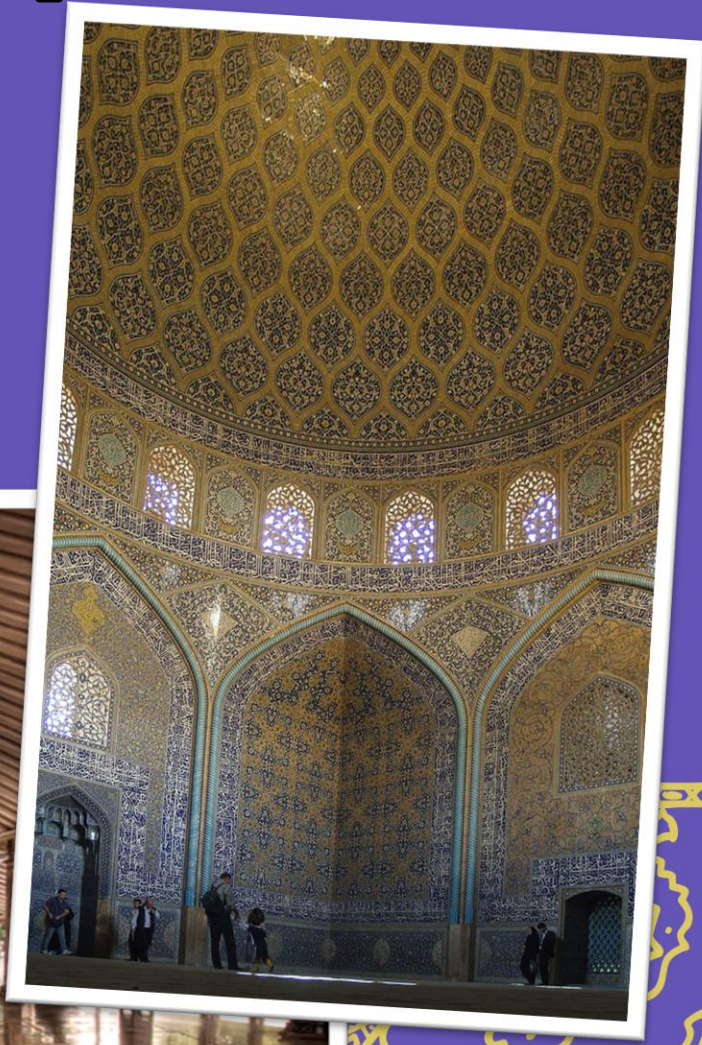
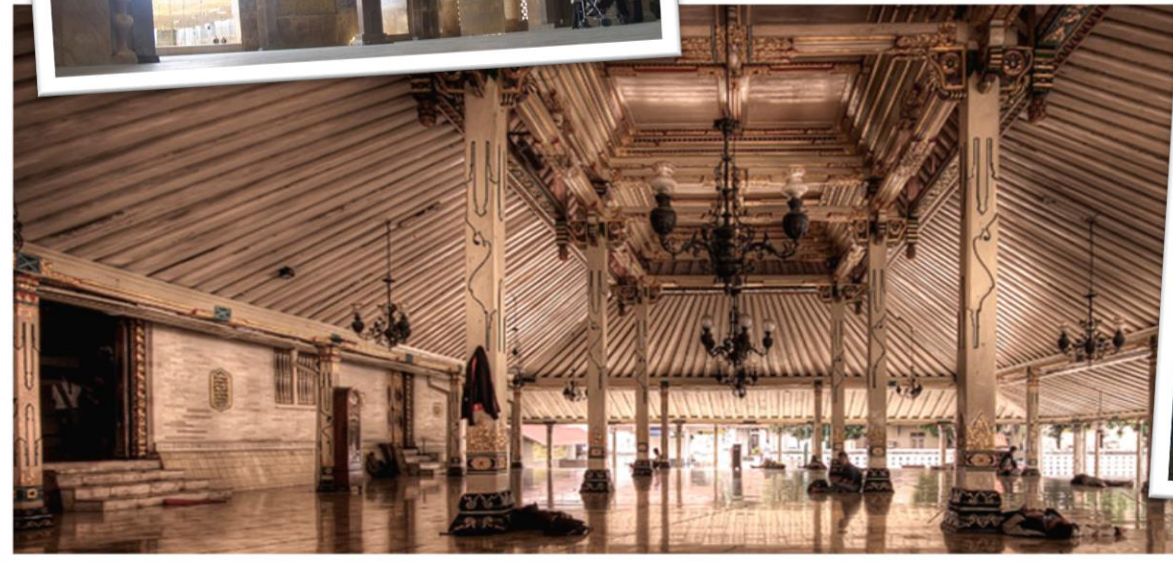
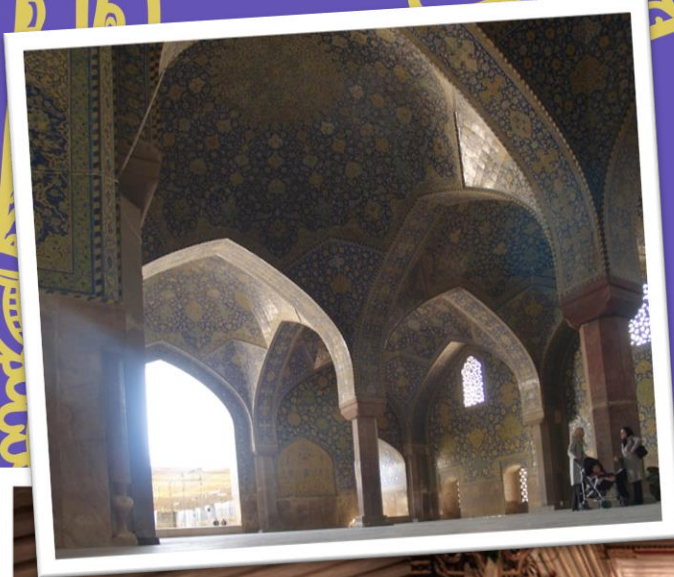

Shoe Rack

A place to leave your shoes before entering.



Prayer Mats

Mosques either have carpet with individual prayer mats or Muslims take their own prayer mat to worship upon.

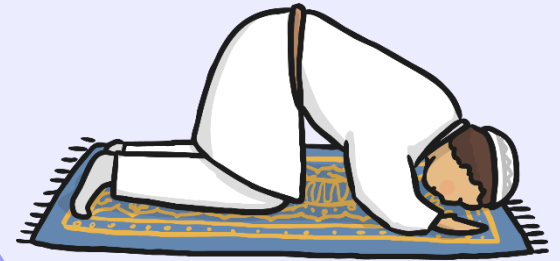

Important Features of a Mosque

Wash Room

Muslims must wash before entering the main hall.

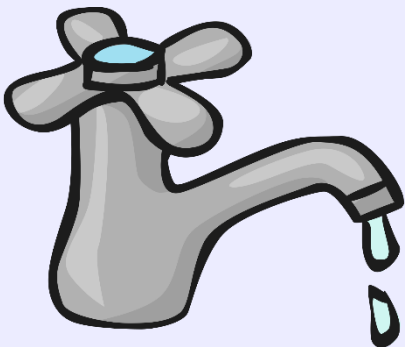

Qur'an

The Muslim holy book which is the word of God. It is treated with great respect and placed on a special wooden stand to be read.

Tasbih Beads

Beads hanging around the mosque for worshippers to help think about Allah.

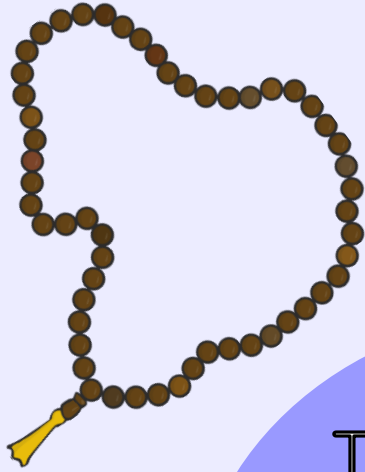

Mihrab

An alcove in the wall shows the direction the worshippers need to face. This is the direction of Mecca in Saudi Arabia, the most sacred Muslim place in the world.

Important Features of a Mosque

Minaret

Most mosques have at least one minaret which is a tall thin tower. A man stands at the top and calls Muslims to prayer.

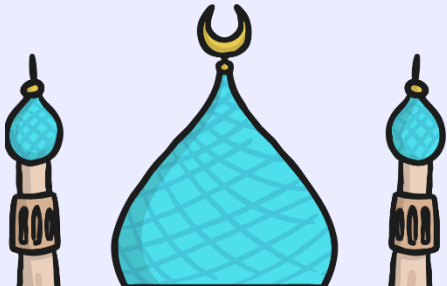

Why do people go to mosque?

Muslims go to mosque to pray and services are held every day. The most important weekly service is held on a Friday.

Many Muslims believe that praying with other Muslims can make you feel part of a family.

Inside a mosque there is often a school where people can learn the Arabic language. This is the language that the Muslim holy book is written in, the Qur'an.

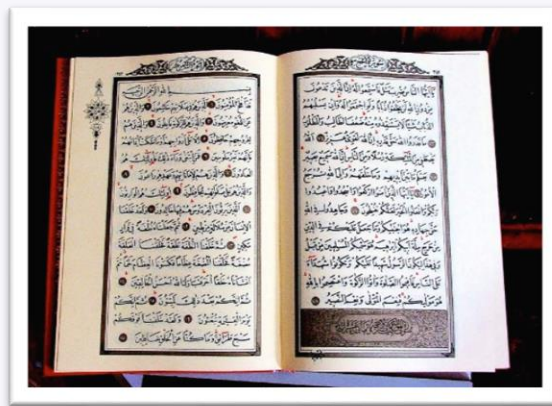

Festivals, weddings and funerals can take place in mosques too.

Showing Respect

- Take off your shoes before entering.
- Wash feet, hands, nose, mouth, throat, ears, arms (up to the elbow) before entering.
- Women and men worship separately.

What's in a Church?



The special place of worship for Christians is called a **church**.

What kind of things do you think you might see in a church?

Talk about your ideas with a partner.

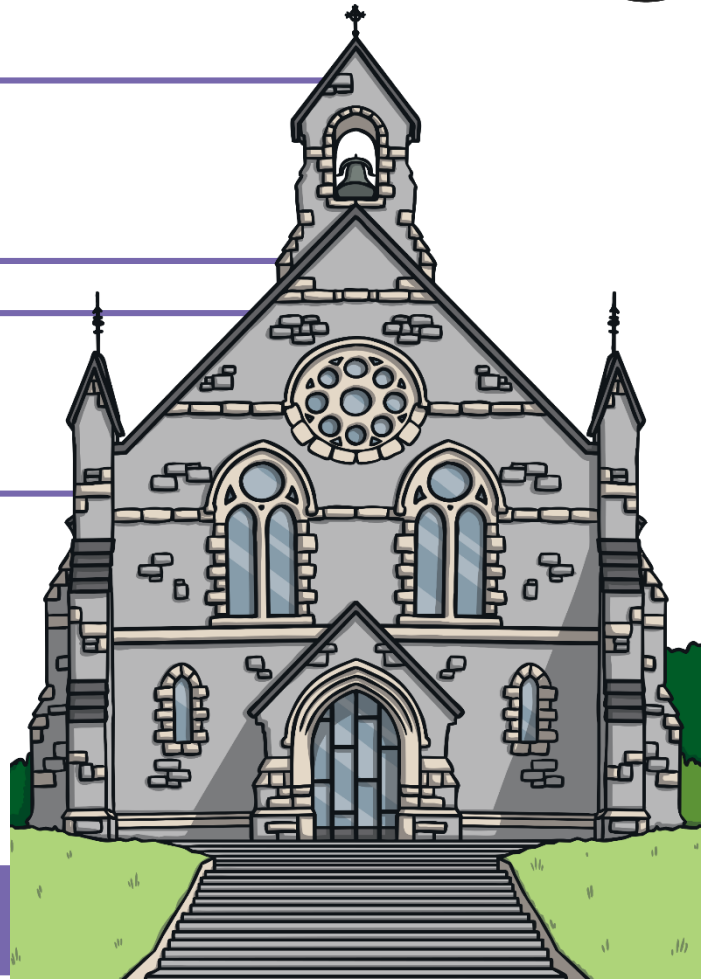

Inside a Church



Not all churches are the same. But there are some things you will find in most churches. Let's take a look at some of them.

Inside a Church



Altar

This is an important part of most church buildings. It is where a special ritual called Holy Communion takes place. The priest, or vicar, stands at the altar to perform Holy Communion. The people in the church gather round to take part and remember Jesus.



Think about it...



Why is the altar an important part of a church?



Inside a Church



Altar

The altar is important because it is where Holy Communion takes place.

This is a special event that happens often to help Christians remember Jesus.



Inside a Church



Font

This is often near a doorway. Fonts can be different shapes and sizes, but all fonts hold water. This water is used for baptism, a special ceremony to mark the beginning of a Christian's faith journey.

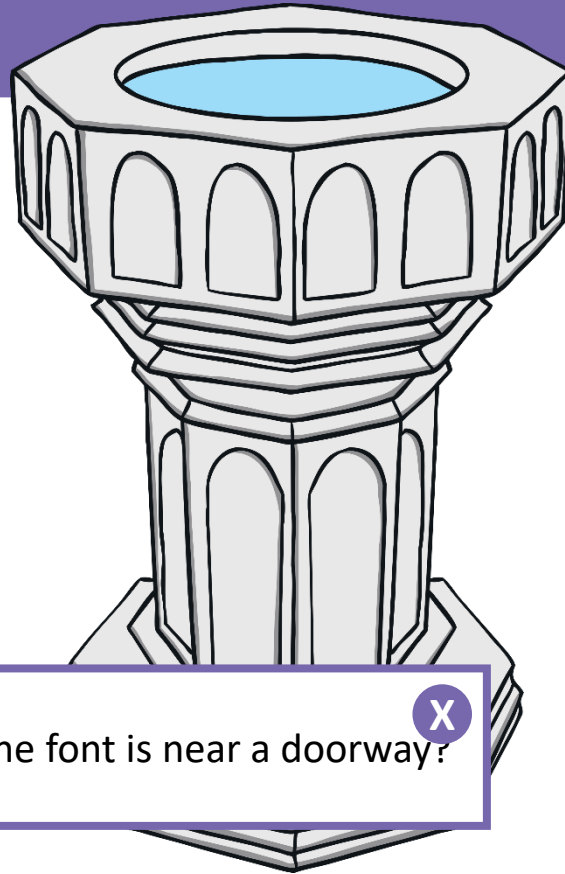

Think about it...



Why do you think the font is near a doorway?



Inside a Church



Font

Fonts are near the doorway as they are part of welcoming people into the Christian community, just like entering a building through a door.

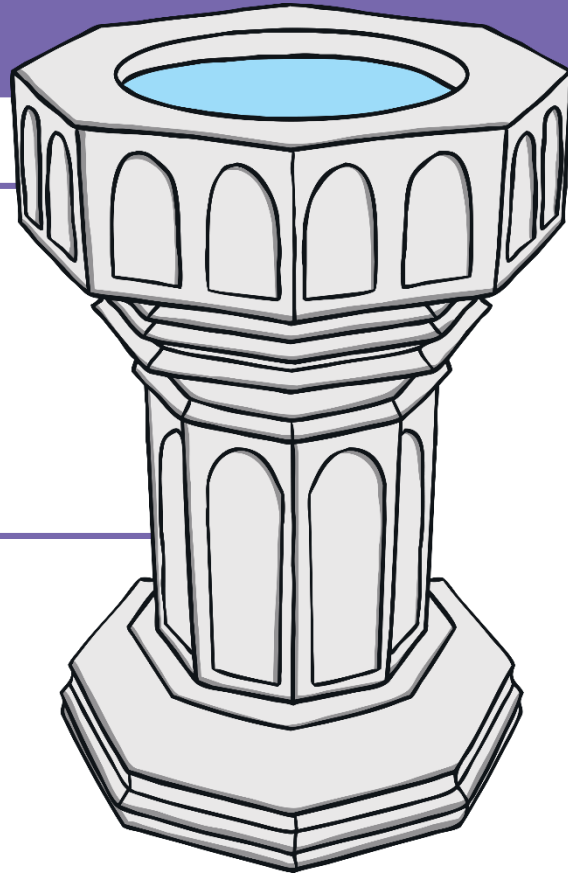

Inside a Church



Lectern

This is where a copy of the Bible will sit. People in church will read sections from the Bible to help them learn about their faith.

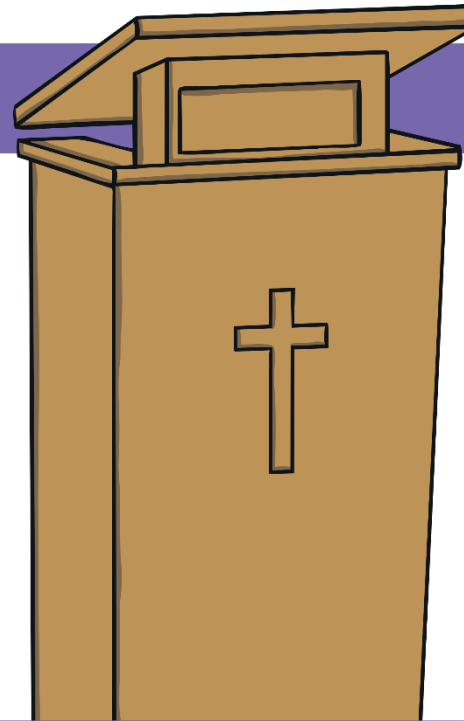

Think about it...



Why might there be a special place for the Bible?



Inside a Church



Lectern

The Bible is a special book for Christians.

Giving it a special place helps to show respect for it.

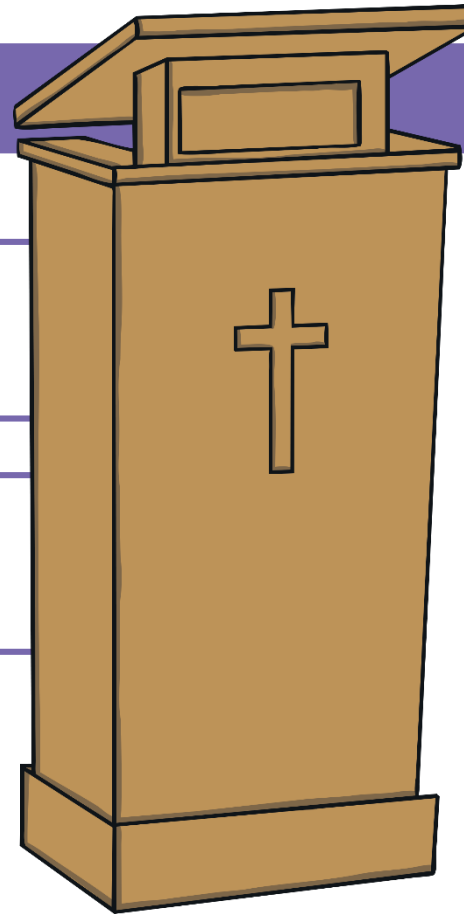

Inside a Church



The Shape of the Building

Church buildings are often built in a special shape. What shape do you think it might be?

Churches are often in the shape of a cross. The cross is an important symbol for Christians. Christians believe that Jesus died on a cross to forgive them for the things they have done so that they could be closer to God.

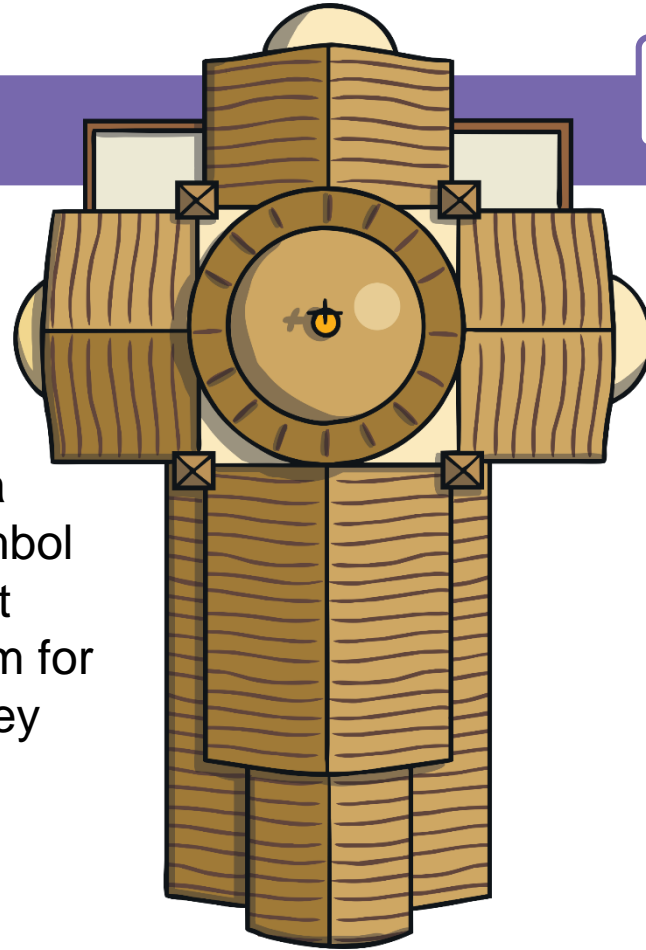

What Happens There?



Christians meet together on Sundays and sometimes at other times of the week. They pray together, read the Bible, learn about God and sing songs.



What Happens There?



Weddings are often celebrated in churches. The priest conducts the ceremony. It often includes readings from the Bible and singing.



What Happens There?



Baptisms happen in churches. This is when people are welcomed into the church and begin their journey of faith. Sometimes this happens when people are young. Sometimes people are baptised as adults, in a larger pool of water.

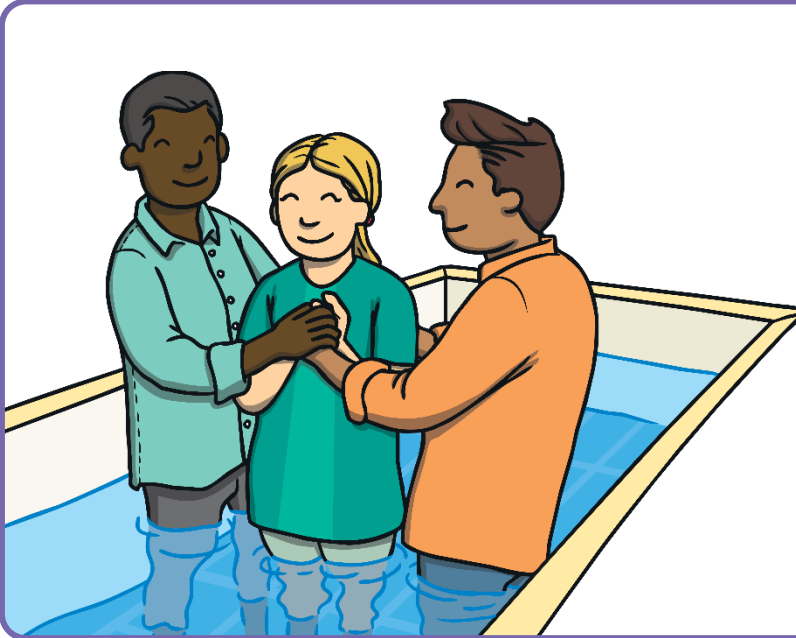

Places of Worship



A task setting PowerPoint about the Jewish synagogue for Key Stage 1.



What Is It like Inside a Jewish Synagogue?



Important Features of a Jewish Synagogue.



Bimah

A raised platform where most of the service takes place. The Torah readings happen here.

Ark

The Ark is a cupboard in which the Torah scrolls are kept.



Siddur

This is the main prayer book.

Important Features of a Jewish Synagogue.

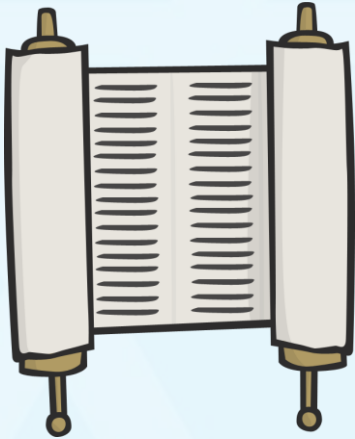

Torah Scrolls

The scrolls contain the words of the Hebrew Bible.

The Eternal Light

This hangs above the Ark and is always burning to remind everyone that God is always with them.

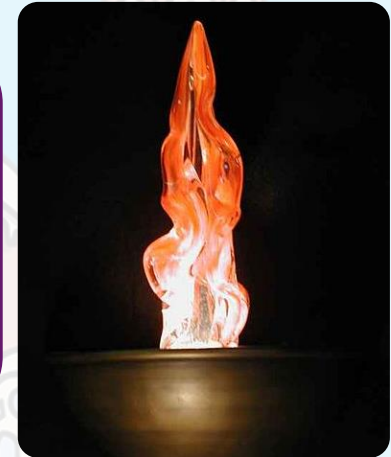

Memorial Boards

These are boards full of name plates. Each name plate remembers someone who has died.

Photos courtesy of Toksook~ (@Wikipedia.org), GlasgowAmateur (@flickr.com) - granted under creative commons licence - attribution

Why Do People Go to a Jewish Synagogue?



People go to the synagogue to worship but also to study. Many synagogues are also community centres where local Jewish people can meet and take part in different activities and events..

A synagogue is a house of prayer where Jewish people can get together to feel closer to God, and each other.

The services are led by a rabbi or a worshipper.

Showing Respect

- During the service everyone, except women who aren't married, must wear a hat to show respect to God; this is called a kippah.
- Adult men wear a prayer shawl for morning prayer which has fringes along the edge to remind the worshipper to follow God's way.
- Men and women sit separately in the synagogue.
- Once the Ark is open, nobody must enter or leave the room as a sign of respect.

